

# NIF9N05CL, NIF9N05ACL

## Protected Power MOSFET

2.6 A, 52 V, N-Channel, Logic Level, Clamped MOSFET w/ ESD Protection in a SOT-223 Package



ON Semiconductor®

<http://onsemi.com>

### Benefits

- High Energy Capability for Inductive Loads
- Low Switching Noise Generation

### Features

- Diode Clamp Between Gate and Source
- ESD Protection – HBM 5000 V
- Active Over-Voltage Gate to Drain Clamp
- Scalable to Lower or Higher  $R_{DS(on)}$
- Internal Series Gate Resistance
- Pb-Free Packages are Available

### Applications

- Automotive and Industrial Markets:  
Solenoid Drivers, Lamp Drivers, Small Motor Drivers

$V_{DSS}$ (Clamped)	$R_{DS(ON)}$ TYP	$I_D$ MAX
52 V	107 mΩ	2.6 A

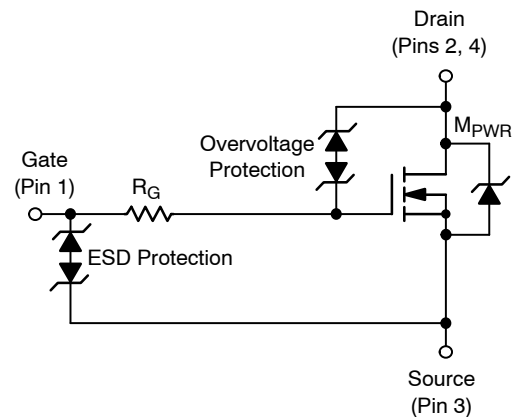

### MAXIMUM RATINGS ( $T_J = 25^\circ\text{C}$ unless otherwise noted)

Rating	Symbol	Value	Unit
Drain-to-Source Voltage Internally Clamped	$V_{DSS}$	52–59	V
Gate-to-Source Voltage – Continuous	$V_{GS}$	±15	V
Drain Current	$I_D$	2.6	A
– Continuous @ $T_A = 25^\circ\text{C}$			
– Single Pulse ( $t_p = 10 \mu\text{s}$ ) (Note 1)	$I_{DM}$	10	
Total Power Dissipation @ $T_A = 25^\circ\text{C}$ (Note 1)	$P_D$	1.69	W
Operating and Storage Temperature Range	$T_J, T_{stg}$	–55 to 150	$^\circ\text{C}$
Single Pulse Drain-to-Source Avalanche Energy ( $V_{DD} = 50 \text{ V}$ , $I_{D(pk)} = 1.17 \text{ A}$ , $V_{GS} = 10 \text{ V}$ , $L = 160 \text{ mH}$ , $R_G = 25 \Omega$ )	$E_{AS}$	110	mJ
Thermal Resistance, Junction-to-Ambient (Note 1)	$R_{\theta JA}$	74	$^\circ\text{C/W}$
Junction-to-Ambient (Note 2)	$R_{\theta JA}$	169	
Maximum Lead Temperature for Soldering Purposes, 1/8" from Case for 10 Seconds	$T_L$	260	$^\circ\text{C}$

Stresses exceeding Maximum Ratings may damage the device. Maximum Ratings are stress ratings only. Functional operation above the Recommended Operating Conditions is not implied. Extended exposure to stresses above the Recommended Operating Conditions may affect device reliability.

1. When surface mounted to a FR4 board using 1" pad size, (Cu area 1.127 in<sup>2</sup>).
2. When surface mounted to a FR4 board using minimum recommended pad size, (Cu area 0.412 in<sup>2</sup>).

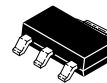

SOT-223  
CASE 318E  
STYLE 3

### MARKING DIAGRAM

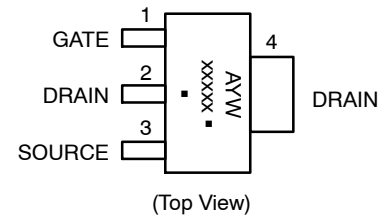

- A = Assembly Location
- Y = Year
- W = Work Week
- xxxxx = F9N05 or 9N05A
- = Pb-Free Package

(Note: Microdot may be in either location)

### ORDERING INFORMATION

See detailed ordering and shipping information in the package dimensions section on page 5 of this data sheet.

# NIF9N05CL, NIF9N05ACL

## MOSFET ELECTRICAL CHARACTERISTICS ( $T_J = 25^\circ\text{C}$ unless otherwise noted)

Characteristic	Symbol	Min	Typ	Max	Unit
----------------	--------	-----	-----	-----	------

### OFF CHARACTERISTICS

Drain-to-Source Breakdown Voltage (Note 3) $(V_{GS} = 0\text{ V}, I_D = 1.0\text{ mA}, T_J = 25^\circ\text{C})$ $(V_{GS} = 0\text{ V}, I_D = 1.0\text{ mA}, T_J = -40^\circ\text{C to } 125^\circ\text{C})$ Temperature Coefficient (Negative)	$V_{(BR)DSS}$	52 50.8	55 54 -9.3	59 59.5	V V mV/ $^\circ\text{C}$
Zero Gate Voltage Drain Current $(V_{DS} = 40\text{ V}, V_{GS} = 0\text{ V})$ $(V_{DS} = 40\text{ V}, V_{GS} = 0\text{ V}, T_J = 125^\circ\text{C})$	$I_{DSS}$			10 25	$\mu\text{A}$
Gate-Body Leakage Current $(V_{GS} = \pm 8\text{ V}, V_{DS} = 0\text{ V})$ $(V_{GS} = \pm 14\text{ V}, V_{DS} = 0\text{ V})$	$I_{GSS}$		$\pm 22$	$\pm 10$	$\mu\text{A}$

### ON CHARACTERISTICS (Note 3)

Gate Threshold Voltage (Note 3) $(V_{DS} = V_{GS}, I_D = 100\ \mu\text{A})$ Threshold Temperature Coefficient (Negative)	$V_{GS(th)}$	1.3	1.75 -4.1	2.5	V mV/ $^\circ\text{C}$
Static Drain-to-Source On-Resistance (Note 3) $(V_{GS} = 3.5\text{ V}, I_D = 0.6\text{ A})$ $(V_{GS} = 4.0\text{ V}, I_D = 1.5\text{ A})$ $(V_{GS} = 10\text{ V}, I_D = 2.6\text{ A})$	$R_{DS(on)}$		190 165 107	380 200 125	m $\Omega$
Forward Transconductance (Note 3) ( $V_{DS} = 15\text{ V}, I_D = 2.6\text{ A}$ )	$g_{FS}$		3.8		Mhos

### DYNAMIC CHARACTERISTICS

Input Capacitance	$V_{DS} = 35\text{ V}, V_{GS} = 0\text{ V},$ $f = 10\text{ kHz}$	$C_{iss}$		155	250	$\mu\text{F}$
Output Capacitance		$C_{oss}$		60	100	
Transfer Capacitance		$C_{rss}$		25	40	
Input Capacitance	$V_{DS} = 25\text{ V}, V_{GS} = 0\text{ V},$ $f = 10\text{ kHz}$	$C_{iss}$		170		$\mu\text{F}$
Output Capacitance		$C_{oss}$		70		
Transfer Capacitance		$C_{rss}$		30		

3. Pulse Test: Pulse Width  $\leq 300\ \mu\text{s}$ , Duty Cycle  $\leq 2\%$ .
4. Switching characteristics are independent of operating junction temperatures.

# NIF9N05CL, NIF9N05ACL

## MOSFET ELECTRICAL CHARACTERISTICS ( $T_J = 25^\circ\text{C}$ unless otherwise noted)

Characteristic	Symbol	Min	Typ	Max	Unit
<b>SWITCHING CHARACTERISTICS (Note 4)</b>					
Turn-On Delay Time	$V_{GS} = 4.5\text{ V}, V_{DD} = 40\text{ V}, I_D = 2.6\text{ A}, R_D = 15.4\ \Omega$	$t_{d(on)}$	275	465	ns
Rise Time			1418	2400	
Turn-Off Delay Time			780	1320	
Fall Time			1120	1900	
Turn-On Delay Time	$V_{GS} = 4.5\text{ V}, V_{DD} = 40\text{ V}, I_D = 1.0\text{ A}, R_D = 40\ \Omega$	$t_{d(on)}$	242		ns
Rise Time			1165		
Turn-Off Delay Time			906		
Fall Time			1273		
Turn-On Delay Time	$V_{GS} = 10\text{ V}, V_{DD} = 15\text{ V}, I_D = 2.6\text{ A}, R_D = 5.8\ \Omega$	$t_{d(on)}$	107		ns
Rise Time			290		
Turn-Off Delay Time			1540		
Fall Time			1000		
Gate Charge	$V_{GS} = 4.5\text{ V}, V_{DS} = 40\text{ V}, I_D = 2.6\text{ A (Note 3)}$	$Q_T$	4.5	7.0	nC
		$Q_1$	0.9		
		$Q_2$	2.6		
Gate Charge	$V_{GS} = 4.5\text{ V}, V_{DS} = 15\text{ V}, I_D = 1.5\text{ A (Note 3)}$	$Q_T$	3.9		nC
		$Q_1$	1.0		
		$Q_2$	1.7		

## SOURCE-DRAIN DIODE CHARACTERISTICS

Forward On-Voltage	$I_S = 2.6\text{ A}, V_{GS} = 0\text{ V (Note 3)}$ $I_S = 2.6\text{ A}, V_{GS} = 0\text{ V}, T_J = 125^\circ\text{C}$	$V_{SD}$	0.81 0.66	1.5	V
Reverse Recovery Time	$I_S = 1.5\text{ A}, V_{GS} = 0\text{ V}, di_S/dt = 100\text{ A}/\mu\text{s (Note 3)}$	$t_{rr}$	730		ns
		$t_a$	200		
		$t_b$	530		
Reverse Recovery Stored Charge		$Q_{RR}$	6.3		$\mu\text{C}$

## ESD CHARACTERISTICS

Electro-Static Discharge Capability	Human Body Model (HBM)	ESD	5000		V
	Machine Model (MM)		500		

3. Pulse Test: Pulse Width  $\leq 300\ \mu\text{s}$ , Duty Cycle  $\leq 2\%$ .

4. Switching characteristics are independent of operating junction temperatures.

# NIF9N05CL, NIF9N05ACL

## TYPICAL PERFORMANCE CURVES

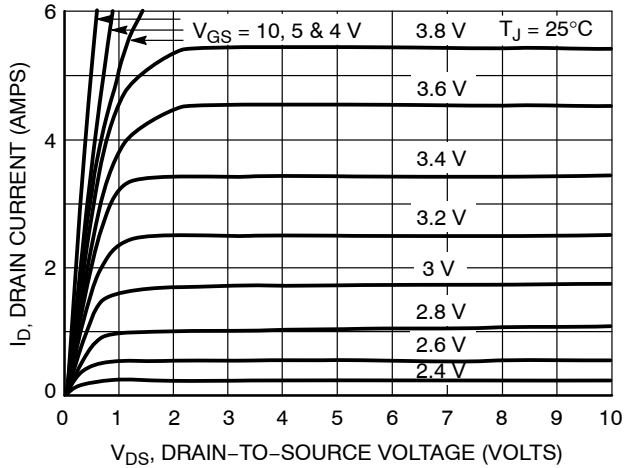

Figure 1. On-Region Characteristics

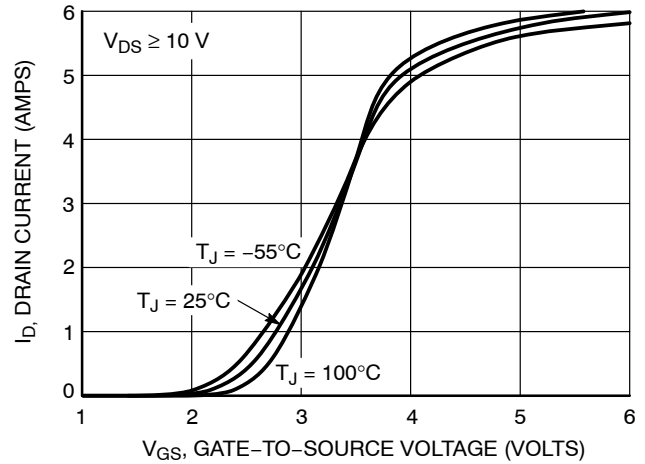

Figure 2. Transfer Characteristics

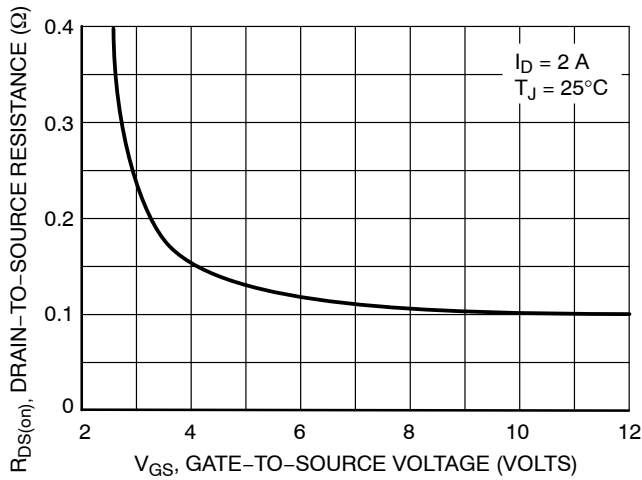

Figure 3. On-Resistance vs. Gate-to-Source Voltage

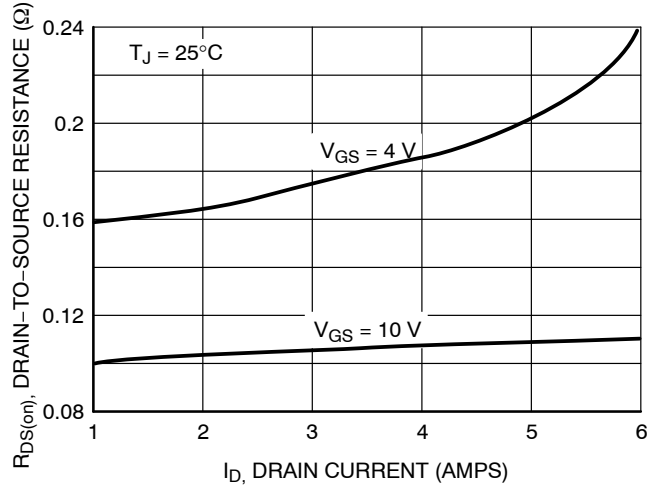

Figure 4. On-Resistance vs. Drain Current and Gate Voltage

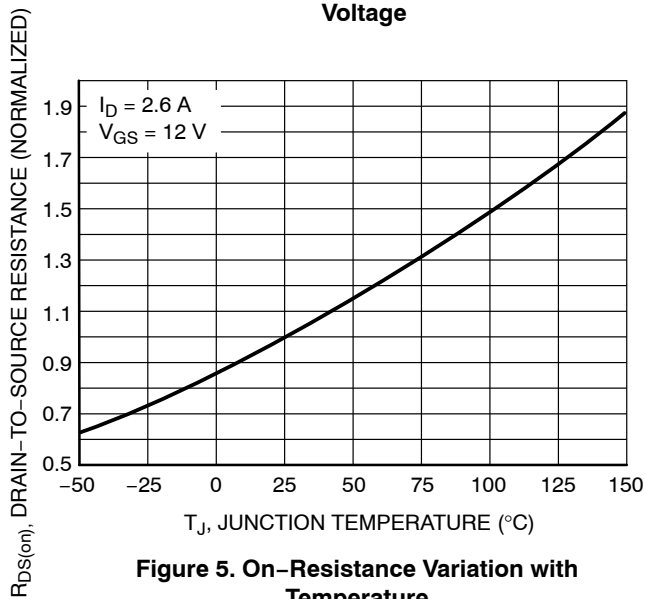

Figure 5. On-Resistance Variation with Temperature

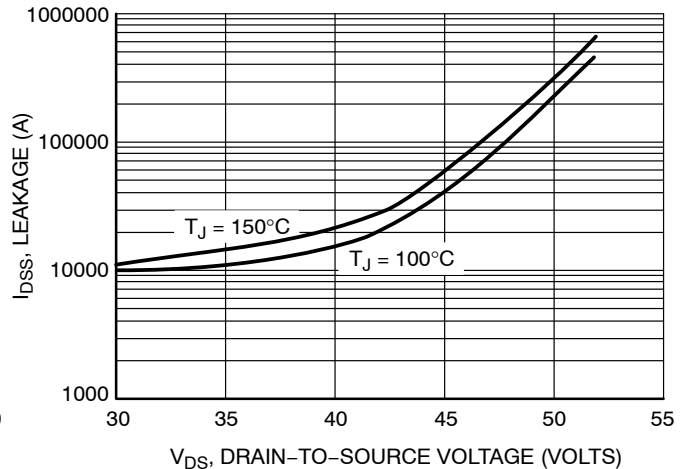
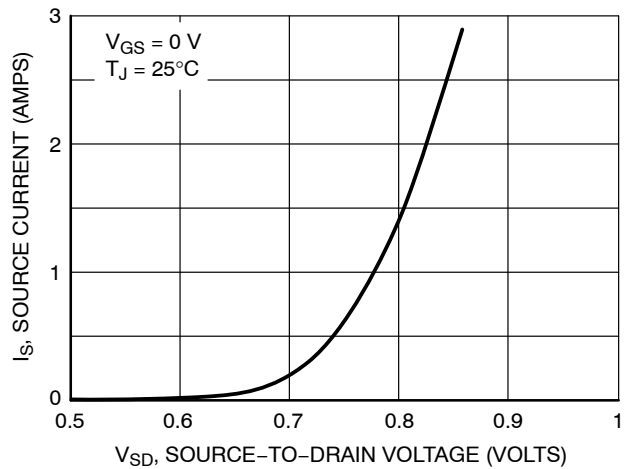
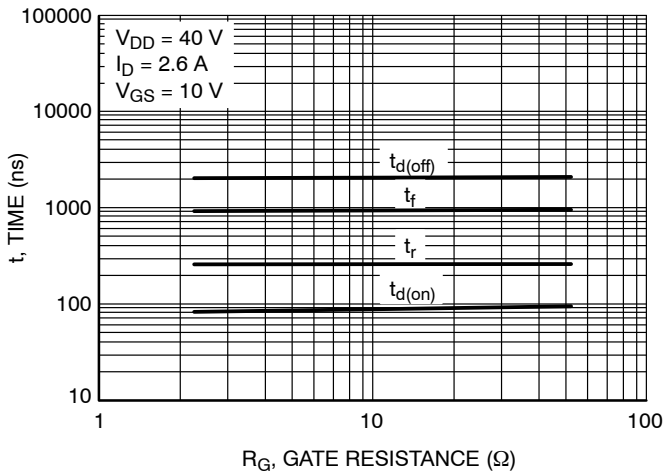
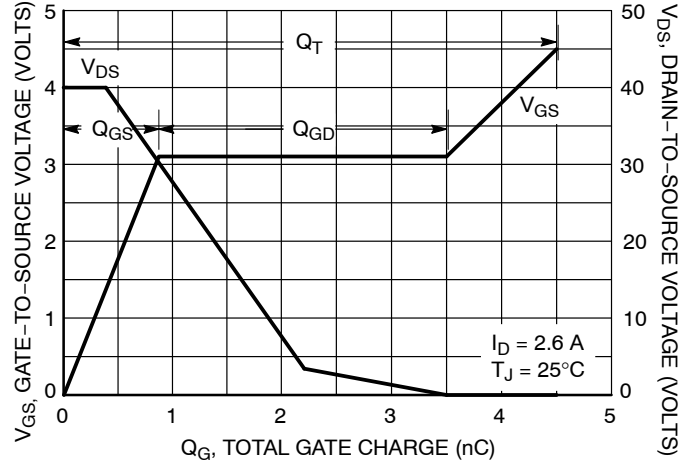
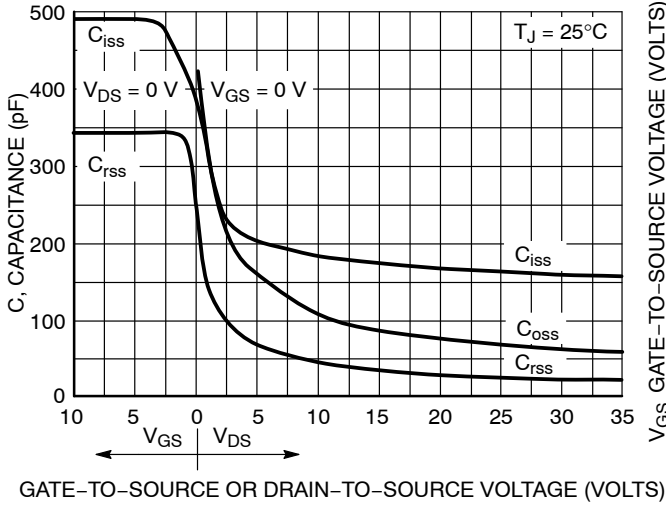

Figure 6. Drain-to-Source Leakage Current vs. Voltage

# NIF9N05CL, NIF9N05ACL

## TYPICAL PERFORMANCE CURVES



### ORDERING INFORMATION

Device	Package	Shipping <sup>†</sup>
NIF9N05CLT1	SOT-223	1000 / Tape & Reel
NIF9N05CLT1G	SOT-223 (Pb-Free)	
NIF9N05ACL1G		
NIF9N05CLT3	SOT-223	4000 / Tape & Reel
NIF9N05CLT3G	SOT-223 (Pb-Free)	
NIF9N05ACL3G		

<sup>†</sup>For information on tape and reel specifications, including part orientation and tape sizes, please refer to our Tape and Reel Packaging Specifications Brochure, BRD8011/D.

# NIF9N05CL, NIF9N05ACL

## PACKAGE DIMENSIONS

SOT-223 (TO-261)  
CASE 318E-04  
ISSUE N

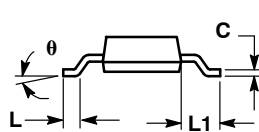
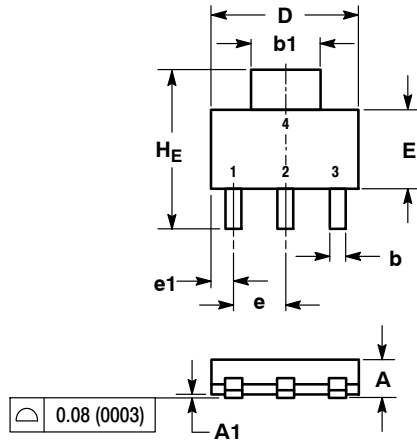

NOTES:

1. DIMENSIONING AND TOLERANCING PER ASME Y14.5M, 1994.
2. CONTROLLING DIMENSION: INCH.

DIM	MILLIMETERS			INCHES		
	MIN	NOM	MAX	MIN	NOM	MAX
A	1.50	1.63	1.75	0.060	0.064	0.068
A1	0.02	0.06	0.10	0.001	0.002	0.004
b	0.60	0.75	0.89	0.024	0.030	0.035
b1	2.90	3.06	3.20	0.115	0.121	0.126
c	0.24	0.29	0.35	0.009	0.012	0.014
D	6.30	6.50	6.70	0.249	0.256	0.263
E	3.30	3.50	3.70	0.130	0.138	0.145
e	2.20	2.30	2.40	0.087	0.091	0.094
e1	0.85	0.94	1.05	0.033	0.037	0.041
L	0.20	---	---	0.008	---	---
L1	1.50	1.75	2.00	0.060	0.069	0.078
HE	6.70	7.00	7.30	0.264	0.276	0.287
theta	0°	---	10°	0°	---	10°

STYLE 3:

- PIN 1. GATE
- DRAIN
- SOURCE
- DRAIN

### SOLDERING FOOTPRINT

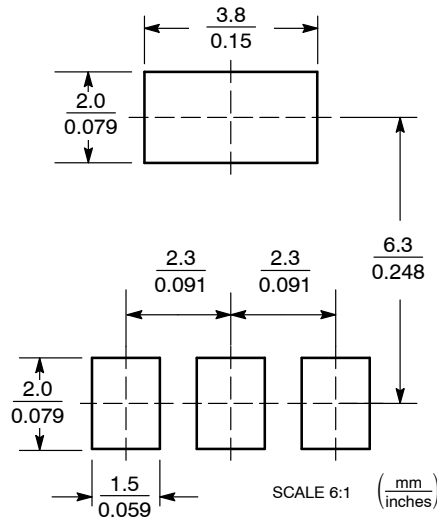

ON Semiconductor and are registered trademarks of Semiconductor Components Industries, LLC (SCILLC). SCILLC reserves the right to make changes without further notice to any products herein. SCILLC makes no warranty, representation or guarantee regarding the suitability of its products for any particular purpose, nor does SCILLC assume any liability arising out of the application or use of any product or circuit, and specifically disclaims any and all liability, including without limitation special, consequential or incidental damages. "Typical" parameters which may be provided in SCILLC data sheets and/or specifications can and do vary in different applications and actual performance may vary over time. All operating parameters, including "Typicals" must be validated for each customer application by customer's technical experts. SCILLC does not convey any license under its patent rights nor the rights of others. SCILLC products are not designed, intended, or authorized for use as components in systems intended for surgical implant into the body, or other applications intended to support or sustain life, or for any other application in which the failure of the SCILLC product could create a situation where personal injury or death may occur. Should Buyer purchase or use SCILLC products for any such unintended or unauthorized application, Buyer shall indemnify and hold SCILLC and its officers, employees, subsidiaries, affiliates, and distributors harmless against all claims, costs, damages, and expenses, and reasonable attorney fees arising out of, directly or indirectly, any claim of personal injury or death associated with such unintended or unauthorized use, even if such claim alleges that SCILLC was negligent regarding the design or manufacture of the part. SCILLC is an Equal Opportunity/Affirmative Action Employer. This literature is subject to all applicable copyright laws and is not for resale in any manner.

### PUBLICATION ORDERING INFORMATION

**LITERATURE FULFILLMENT:**  
Literature Distribution Center for ON Semiconductor  
P.O. Box 5163, Denver, Colorado 80217 USA  
**Phone:** 303-675-2175 or 800-344-3860 Toll Free USA/Canada  
**Fax:** 303-675-2176 or 800-344-3867 Toll Free USA/Canada  
**Email:** orderlit@onsemi.com

**N. American Technical Support:** 800-282-9855 Toll Free  
USA/Canada  
**Europe, Middle East and Africa Technical Support:**  
Phone: 421 33 790 2910  
**Japan Customer Focus Center**  
Phone: 81-3-5817-1050

**ON Semiconductor Website:** [www.onsemi.com](http://www.onsemi.com)

**Order Literature:** <http://www.onsemi.com/orderlit>

For additional information, please contact your local Sales Representative